

THULE[®]
SWEDEN

Thule Motion XT 6292 6295 6296 6298 6299

➤ Instructions

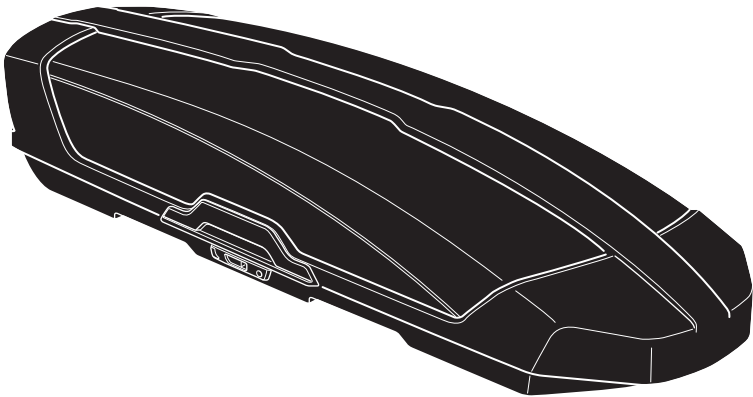

Roof box



CITY CRASH
Complies with ISO norm

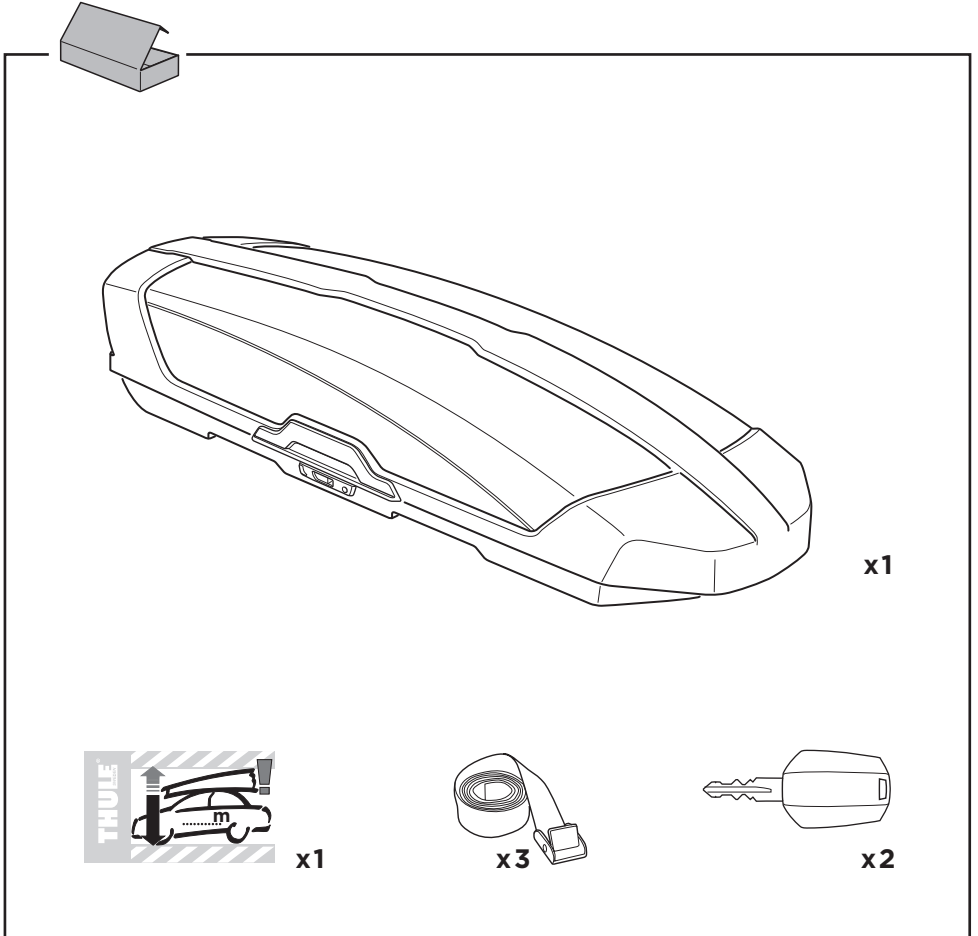
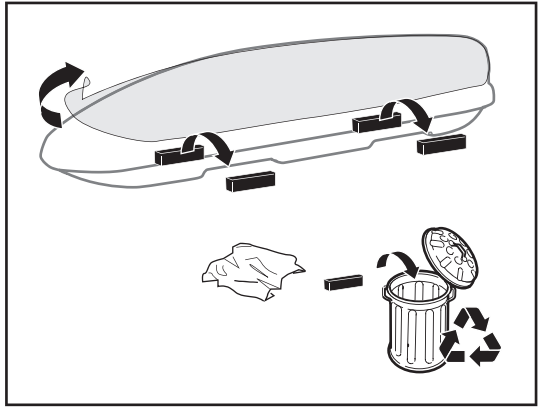

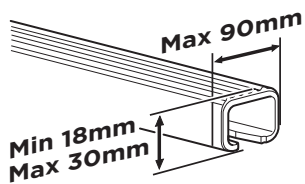
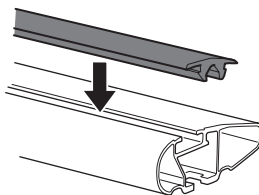
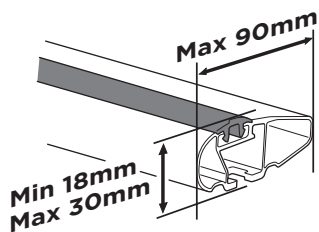
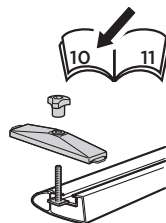
i**Thule T-track Adapter****696600****697600**

	D Min*	D Max*	W in*	W out*	H*	R Min*
M	560	930	755	865	460	450
Sport	560	930	565	675	430	500
XL	560	930	805	915	440	600
XXL	560	930	840	950	470	690
Alpine	560	930	840	950	350	670



*mm

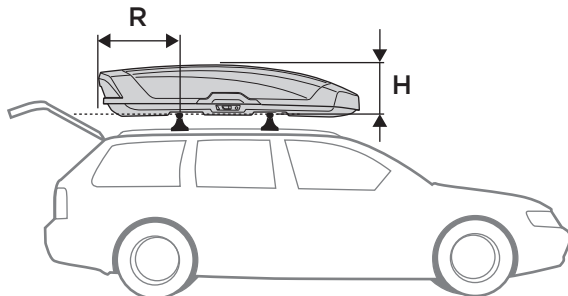
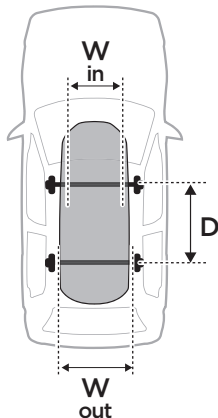

1

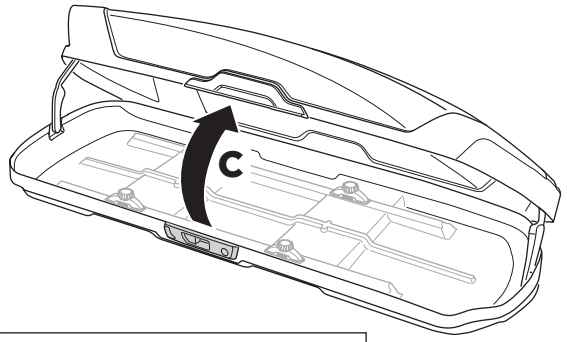
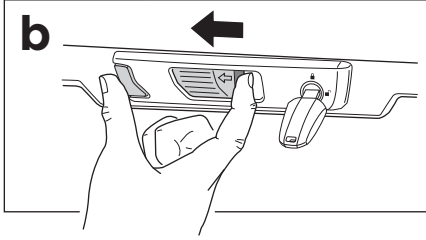
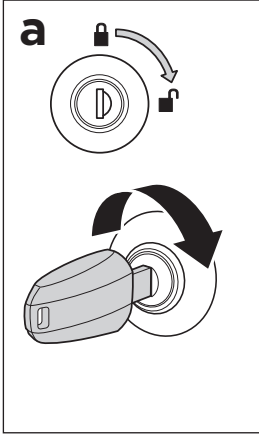

2

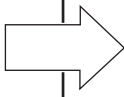
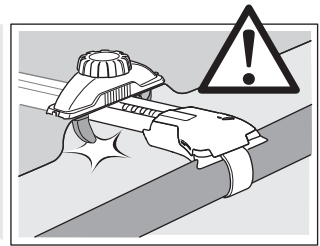
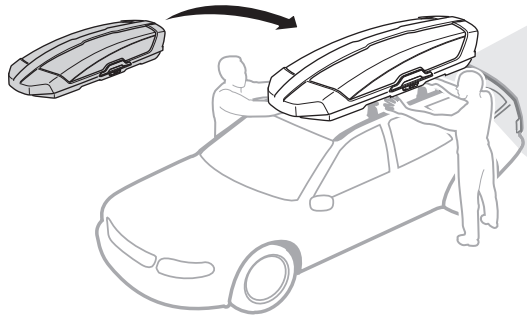
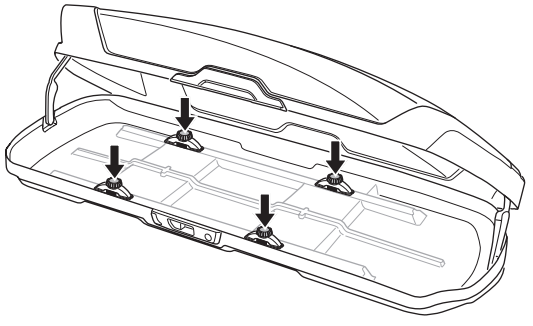
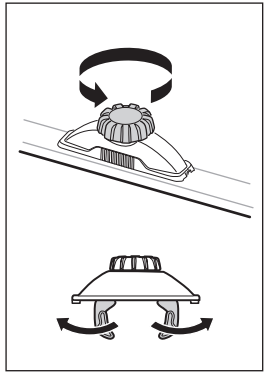

3

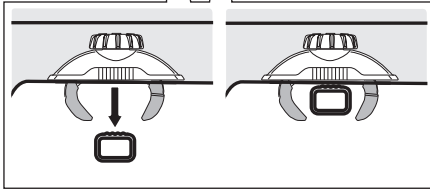
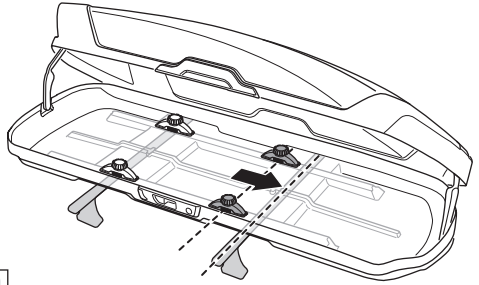
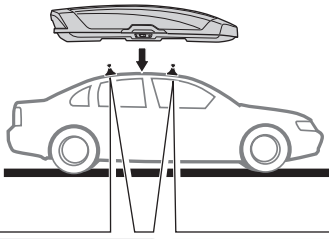
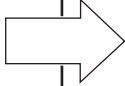

4

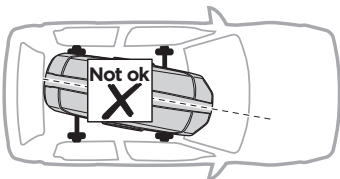
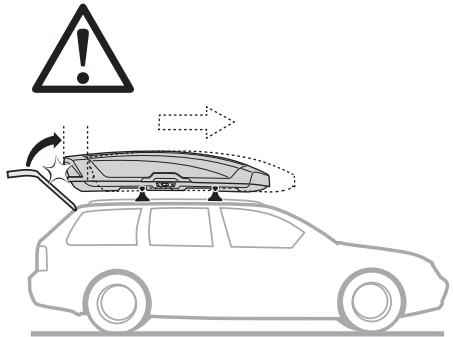
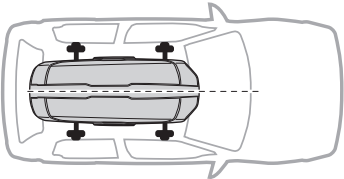

5

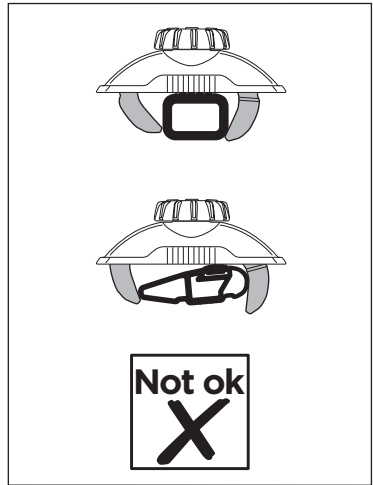
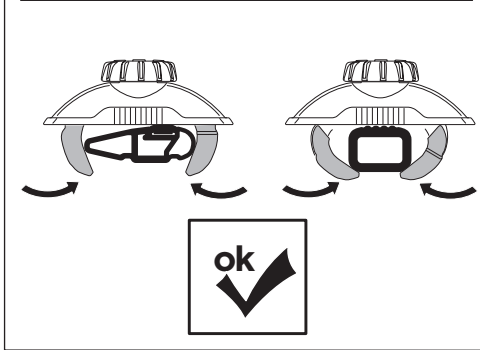
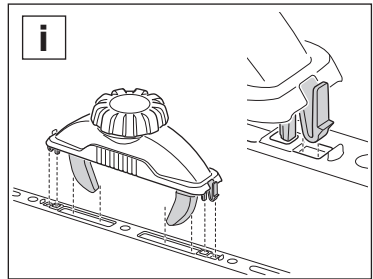
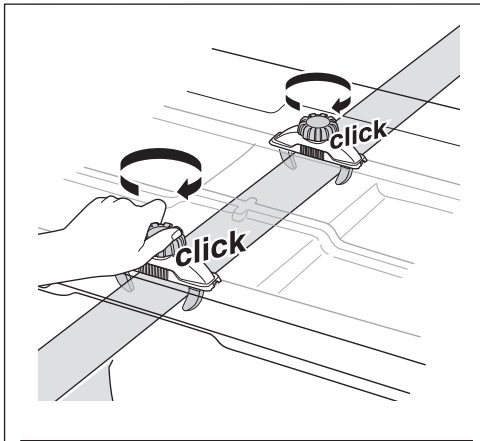
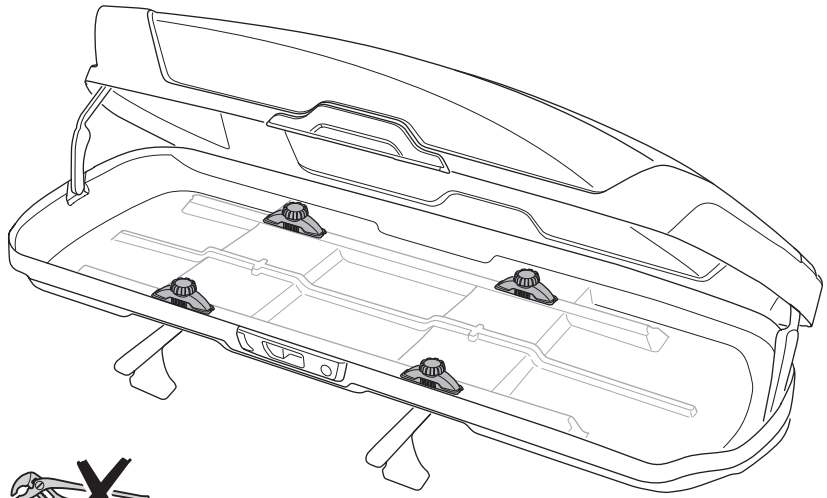

6

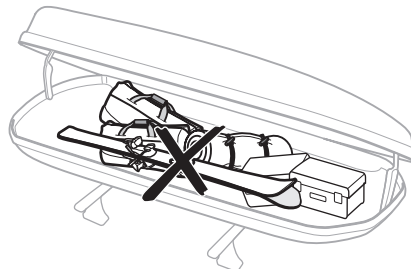
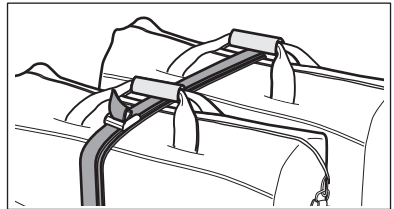
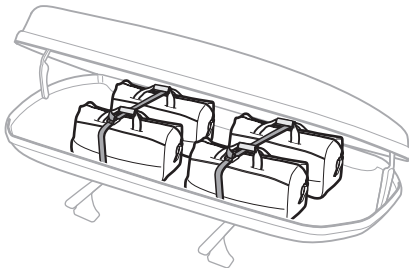
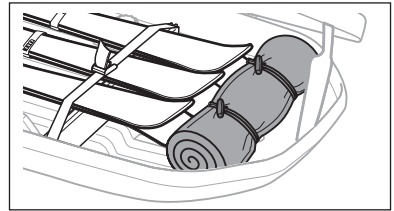
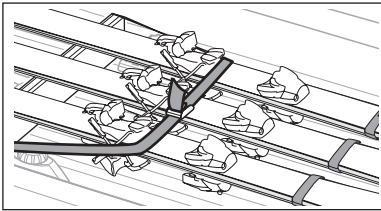
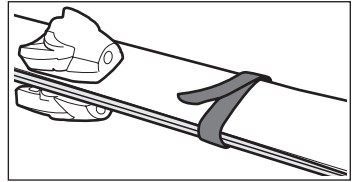
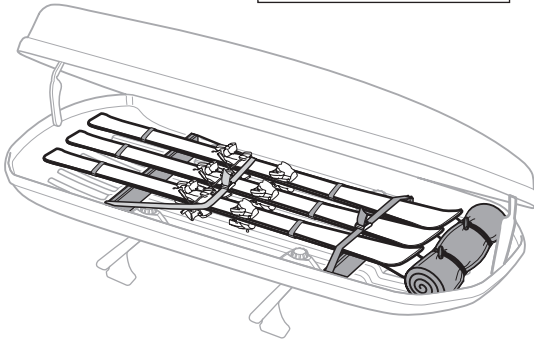
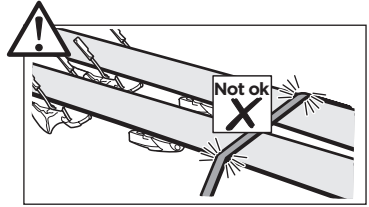
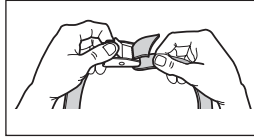

7

a

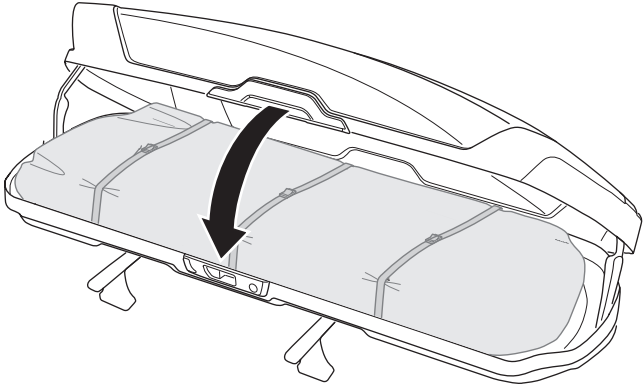

b

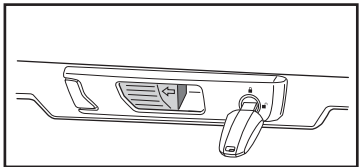
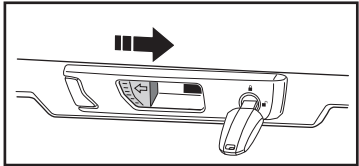
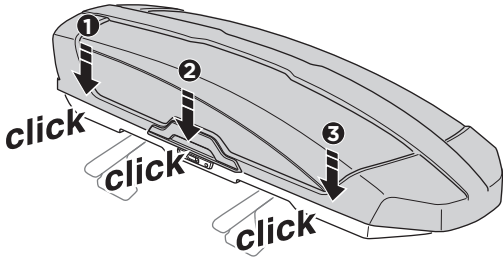

c

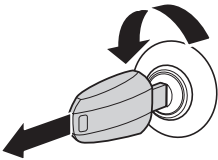
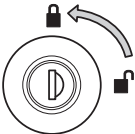
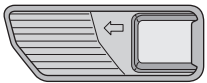
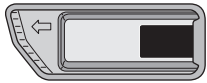

8

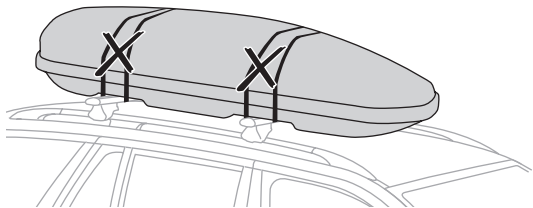
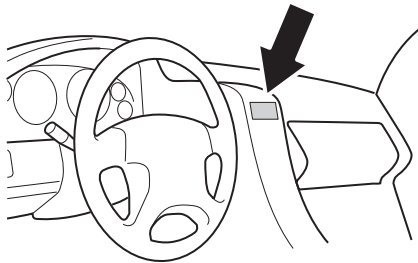
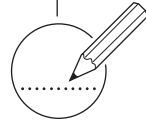
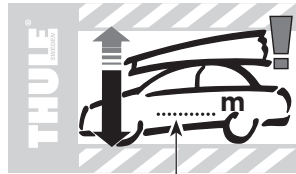
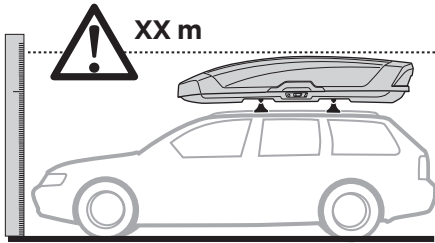
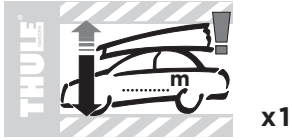

Thule T-track Adapter

696600 → 24x30 mm

697600 → 20x27 mm

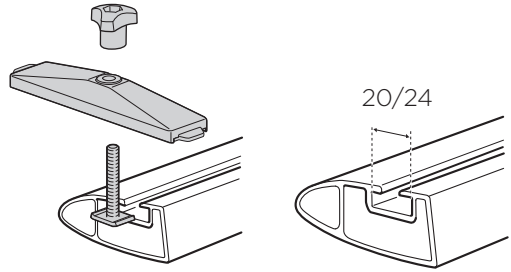

Thule MultiLift

572004

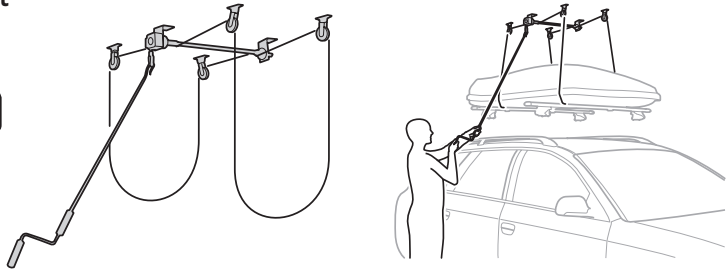

Thule Box Ski Carrier Adapter

694600 → Sport

694800 → M

694900 → XL/XXL/Alpine

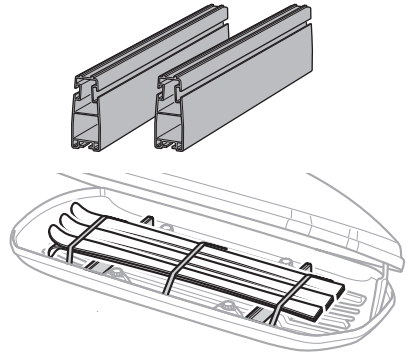

Thule Box Lid Cover

698100 → M

698200 → Sport

698300 → XL/Alpine

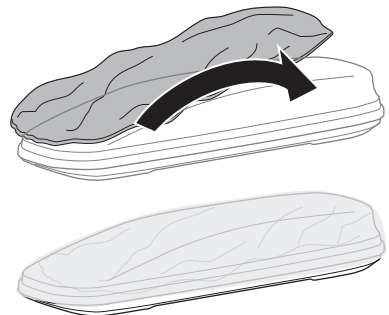

698400 → XXL

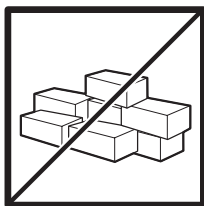
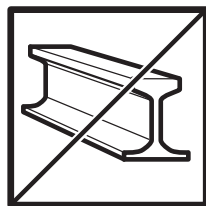
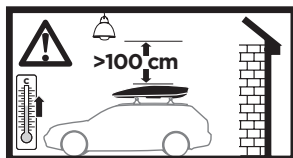
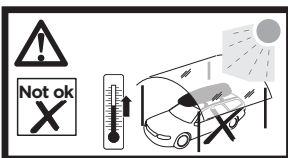
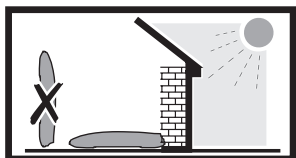
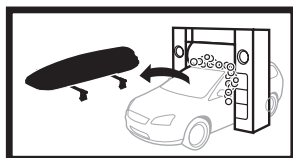
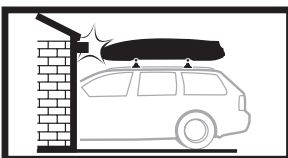
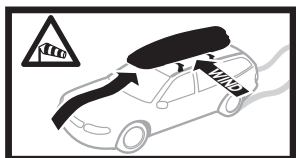
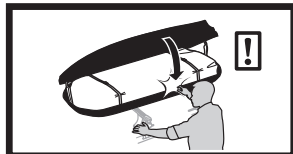
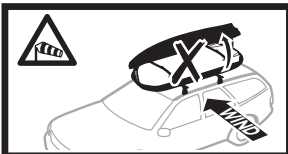
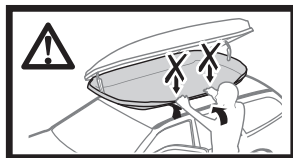
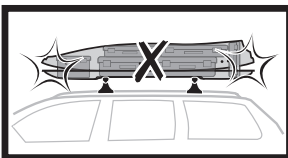
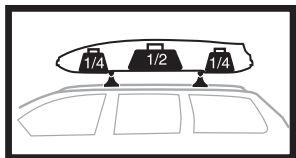





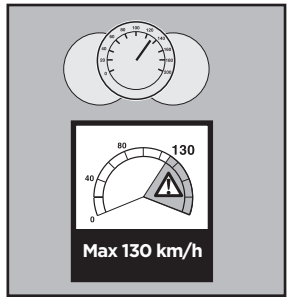
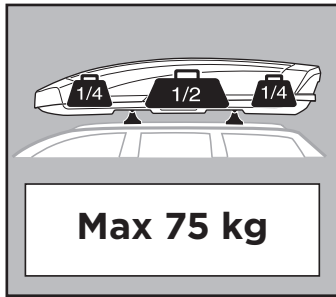



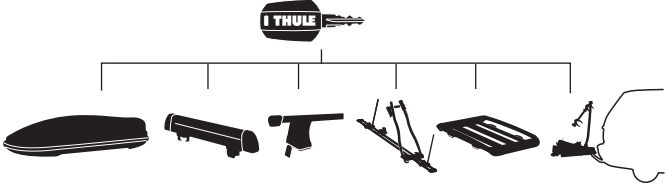

Sport	16 kg
M	17,5 kg
XL	23,5 kg
XXL	25,5 kg
Alpine	25,5 kg

Thule One-Key System

- 544  (x4)
- 596  (x6)
- 588  (x8)
- 452  (x12)

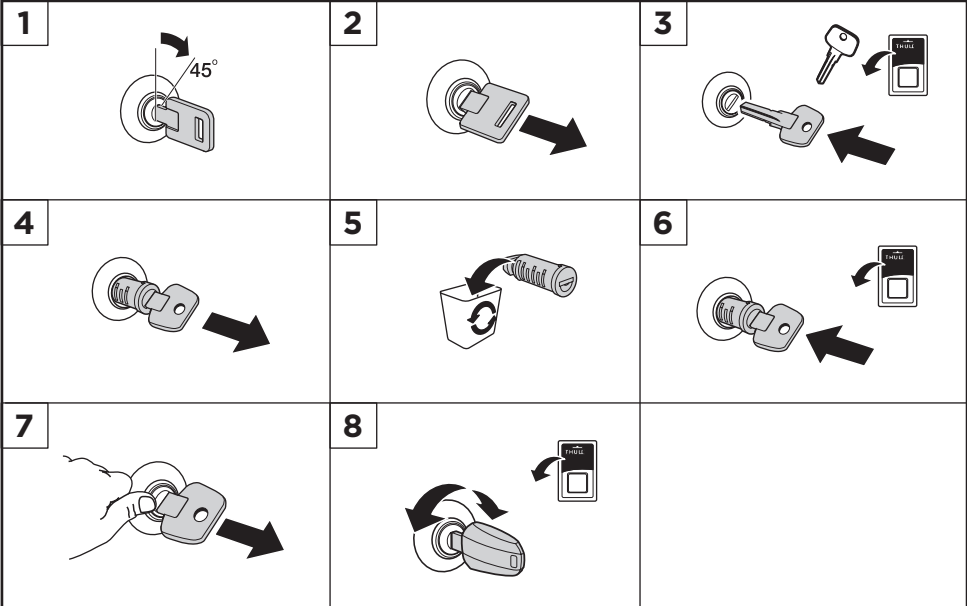

1. Insert the key into the lock cylinder at a 45-degree angle.
2. Turn the key clockwise to the right.
3. Push the key into the lock cylinder.
4. Turn the key clockwise to the right.
5. Insert the cylinder into the lock housing.
6. Push the key into the lock cylinder.
7. Turn the key clockwise to the right.
8. Turn the key counter-clockwise to the left.